



Savi 8445 Office

DECT Wireless Headset System

User Guide

Contents

DECT Information	4	
DECT Enhanced Security		4
Overview	5	
Your headset system		5
Headset Basics	5	
Base overview	5	
Accessories	6	
Connect your headset system		7
Desk phone setup details		7
Position Your Base	9	
Fit	10	
Customize Your Headset		10
Charge	15	
Charge your headset and spare battery		15
Talk time	15	
Headset battery status	15	
Replace rechargeable battery		16
Load software	17	
Update your Poly device		17
Pair to your mobile phone		18
Auto connect feature	18	
Transfer mobile audio	18	
Disconnect your mobile phone		18
The basics	19	
Headset Basics	19	
Power on your headset		19
Adjust volume	19	
Launch Microsoft Teams (Teams model only)		19
Change your default line	20	
Get a dial tone	20	
Stream audio	20	
Make, answer, end calls		21
Make a call	21	
End/take a call	21	
Mute	21	
Answer a second call	21	
Reject a Mobile Call	21	
Merge a call from 2 sources		21
Set up a conference call	22	
More Features	23	
Change voice prompt language		23
Optimize audio quality	23	
Limit office noise	23	
Remove or connect a headset charge cradle		23
Set the range	23	
Automatic secure subscription		24
Troubleshooting	25	
Headset	25	
Desk Phone	26	
Mobile	26	
Softphone	27	
Safety warnings	29	
Safety Instructions		29

Support 31

DECT Information

DECT products should never be used outside the region in which they were originally purchased and intended to be used.

The enclosed DECT 6.0 wireless product uses restricted wireless radio frequencies which vary by country. DECT 6.0 devices are generally authorized for use in the US/Canada/Mexico. Use of this DECT 6.0 product in unauthorized countries is a violation of law, may disrupt telecommunications networks and devices, and can subject you to fines and penalties by regulatory agencies.

DECT Enhanced Security

Poly is a member of the DECT Forum and has fully adopted their recommendations for enhancements to security within all DECT products.

Poly DECT-based products now fully incorporate the latest recommendations on Enhanced Security from the DECT Forum and ETSI. These improvements cover registration, authentication, authorization and encryption procedures. Poly DECT products are now secure against known vulnerabilities that were highlighted by the public announcements of the Chaos Communication Congress in 2009.

Poly DECT products have been tested against and passed the DECT Forum security certification requirements and consequently have been granted 'DECT Forum security' logo certification.

Poly DECT products using the new enhanced version of DECT that includes these security improvements are marked on the base with the DECT Forum security logo.



Overview

Your headset system

Your DECT™ headset system has 3-way connectivity to computer, desk phone and mobile phone.

Headset Basics

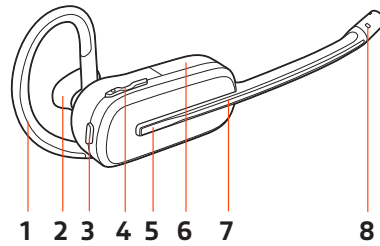

- 1 Earloop
- 2 Eartip
- 3 Mute button
- 4 Volume button
- 5 Call button/Press to interact with Microsoft Teams (app required)
- 6 Battery
- 7 Headset LED
- 8 Microphone

Be safe

Please read the safety guide for important safety and regulatory information before using your new device.

Base overview

Front view

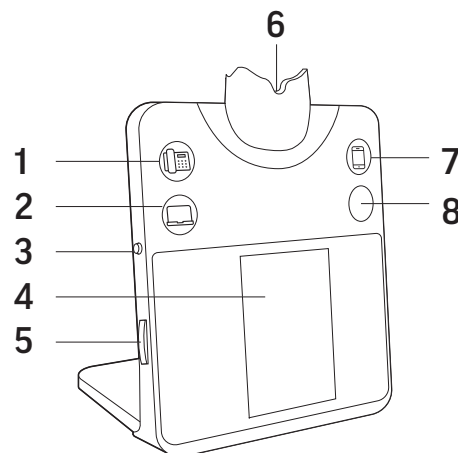

- 1 Desk phone button
- 2 Computer button
- 3 Back button
- 4 Base screen

- 5 Navigation wheel (scroll/press)
- 6 Headset charge cradle
- 7 Mobile phone button
- 8 Mute button or Microsoft Teams button (varies by model)

Back view

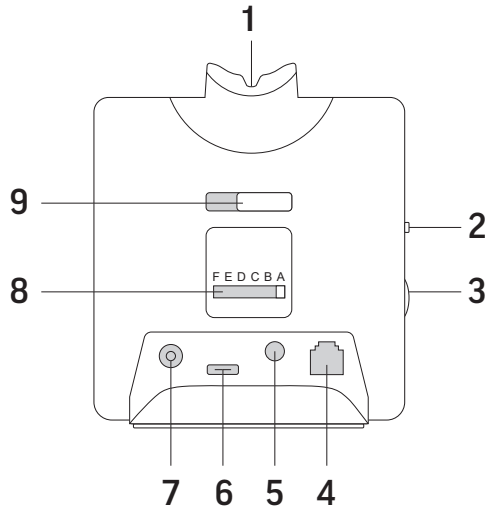

- 1 Headset charge cradle
- 2 Back button
- 3 Navigation wheel (scroll/press)
- 4 Telephone interface cable jack
- 5 Handset lifter jack
- 6 Computer cable USB-C port
- 7 Power jack
- 8 Desk phone configuration switch
- 9 Cradle release slider

Accessories

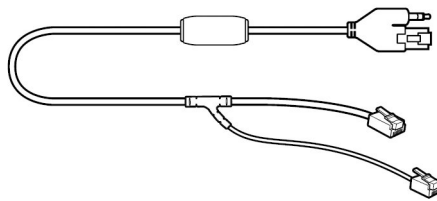

1

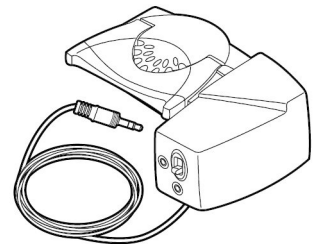

2

- 1 **Electronic hookswitch cable (EHS cable)** Electronically and automatically answers/ends a desk phone call. Enables remote call control with your headset.
- 2 **HL10 lifter** Automatically lifts handset and returns it to the cradle. Enables remote call control with your headset.

Connect your headset system

Using the diagram, connect the base to your computer, power outlet and desk phone's headset port, if available. Otherwise, connect the base to your handset port.

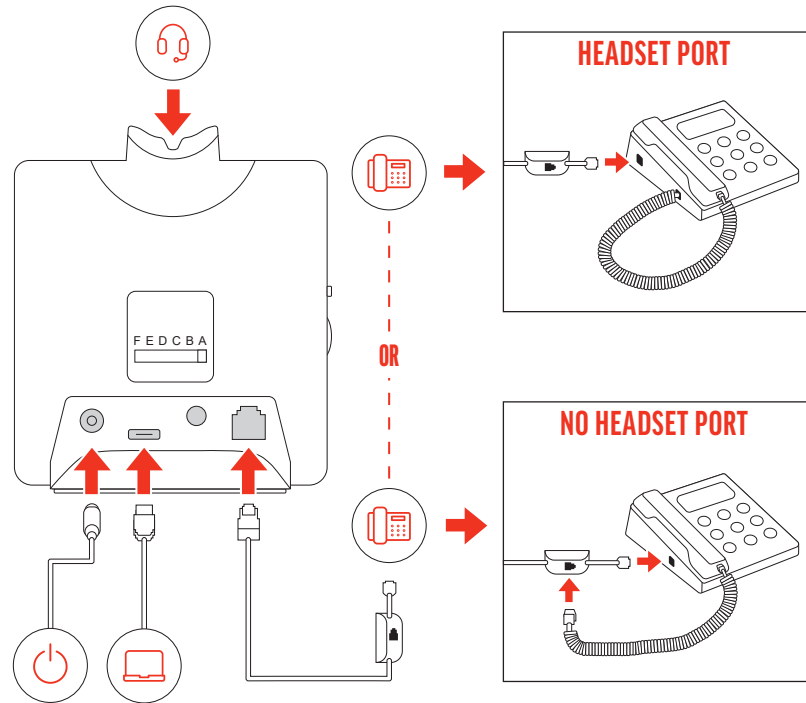

Desk phone	Base configuration setting (on back of base)
Most phones	A
Cisco phones	D
Cisco phones with EHS cable	A

Desk phone setup details

Your desk phone setup method varies by desk phone and connection accessories.

Choose a desk phone setup **A**, **B**, **C** or **D** and connect cables.

A Desk phone with dedicated headset port

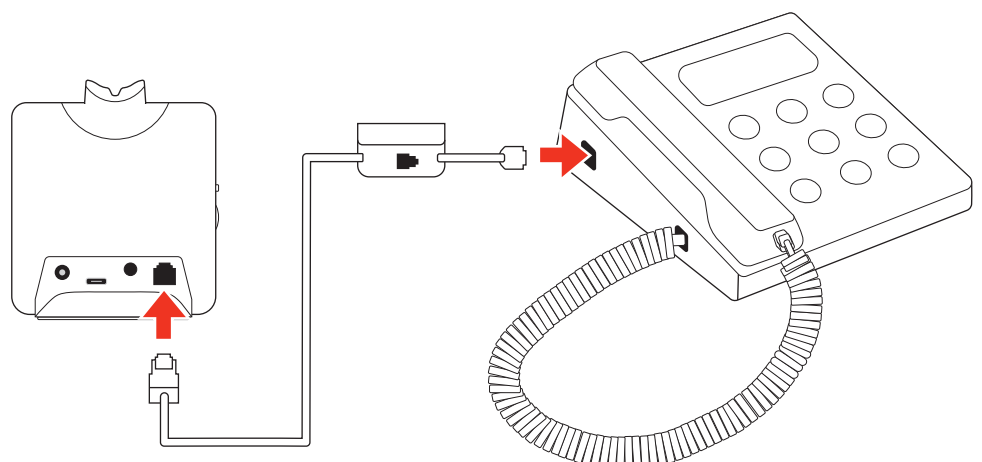

- Connect one end of the telephone interface cable to the back of the base
- Connect the other end of the telephone interface cable into the dedicated headset port on the desk phone

Important: Cisco phones use configuration **D** on the back of the base. Most other phones use default configuration **A**. Use this setup if you are not using the HL10 lifter or EHS cable. In this configuration, press both the headset button on your desk phone and the call control button on the headset to answer or end calls.

B Desk phone (standard)

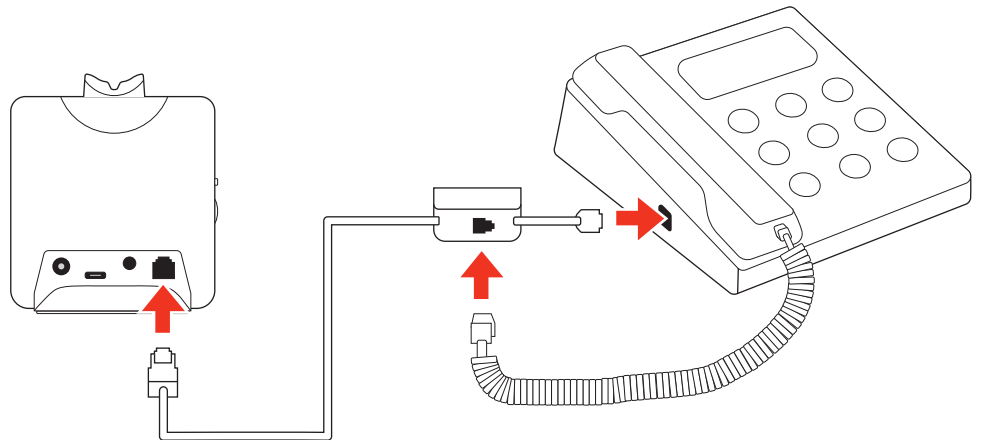

- Connect one end of the telephone interface cable to the back of the base
- Disconnect the handset coil cord from the base of the desk phone and re-connect it to the telephone interface cable junction box
- Finally connect the remaining end of the telephone interface cable into the open handset port on the desk phone

Important: Cisco phones use configuration **D** on the back of the base. Most other phones use default configuration **A**.

Note: Use this setup if you are not using the HL10 lifter or EHS cable and your desk phone does not have a dedicated headset port. In this configuration, manually remove the handset on your desk phone and press the call control button on the headset to answer or end calls.

C Desk phone + EHS cable (sold separately)

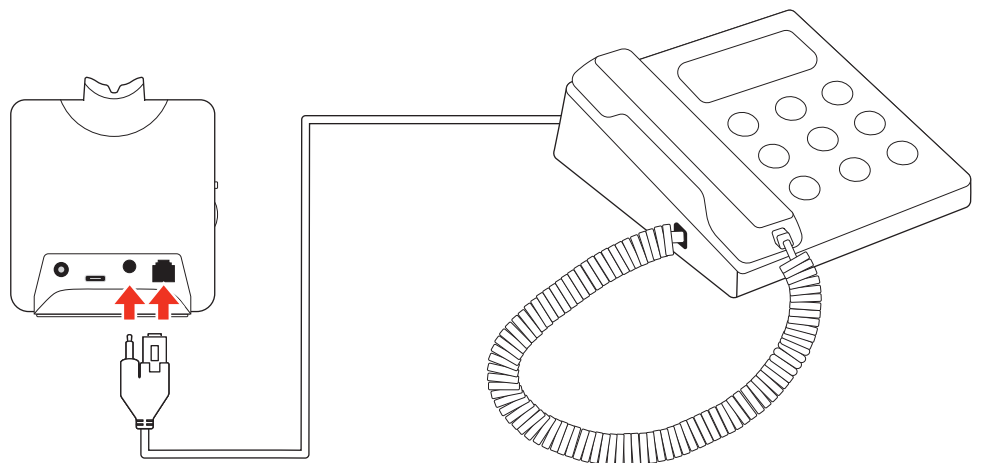

Important: Use configuration **A** on the back of the base, which works for most phones including Cisco phones.

D Desk phone + HL10 lifter (sold separately)

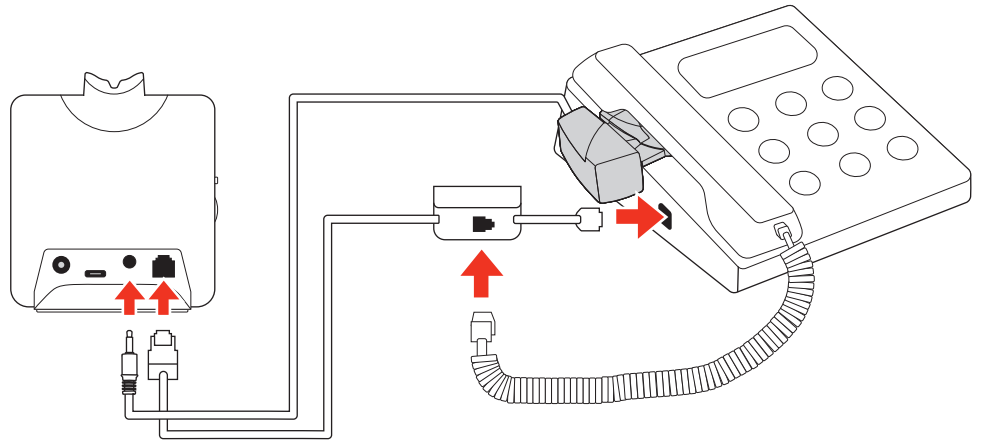

Important: Cisco phones use configuration **D** on the back of the base. Most other phones use default configuration **A**.

Position Your Base

The minimum recommended separation between your desk phone and the base is 6 inches.

The minimum recommended separation between the base and computer is 12 inches. Incorrect position can cause noise and interference problems.

Note: Headset cradle may vary, but function is the same.

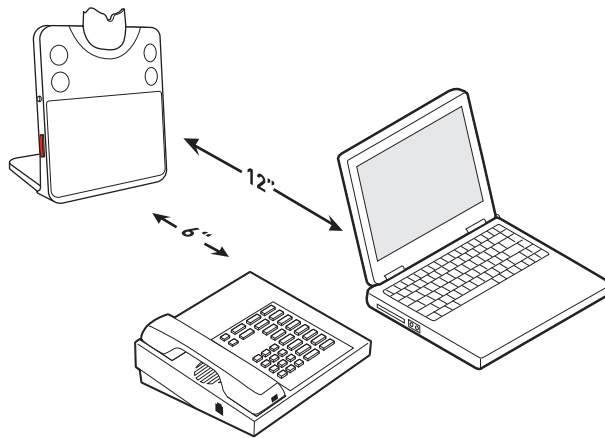

Fit

Customize Your Headset

After you install the headset battery, choose one of the three headset wearing styles, over-the-ear, over-the-head or behind-the-head. Use the fit kit to assemble it and optimize the position of the microphone.

Install the headset battery

Position the battery as shown on the headset and slide into position until the battery snaps into place.

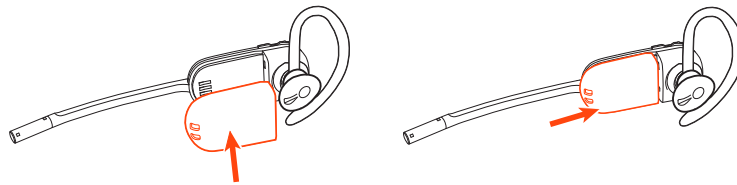

Note: This product has a replaceable battery. Use only the battery type supplied by Poly.

Use the fit kit to assemble your headset

Choose a headset wearing style and use the fit kit to assemble it over-the-ear, over-the-head or behind-the-head.

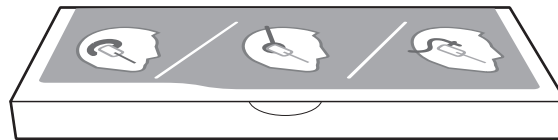

Right over-the-ear assembly

- 1 Choose the size of earloop that fits most comfortably. Align the earloop as shown and insert it onto the headset. Rotate the earloop up 90°.

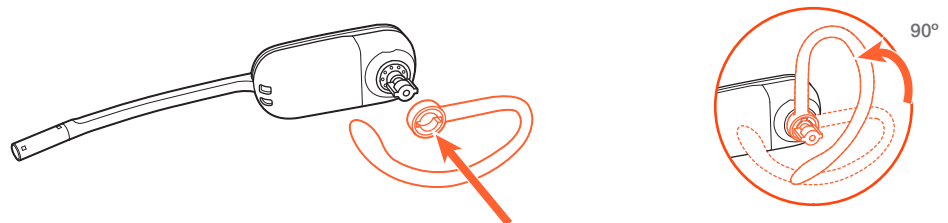

Note: Ensure the earloop is flat against the headset before rotating.

- 2 Choose the size and style of eartip that fits most comfortably. Align the eartip with the notch facing the microphone as shown. Press on to attach.

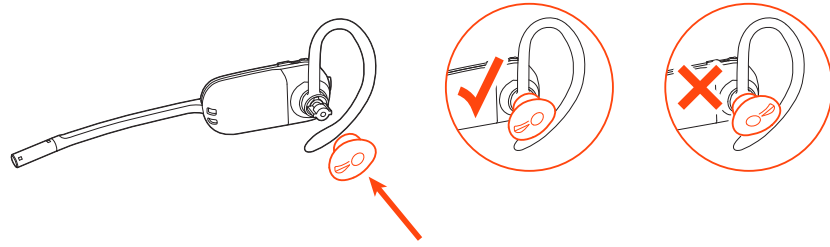

Note: Ensure the large end of the eartip points to the microphone.

- 3 To correctly position your headset, see [Position Your Headset](#).

Left over-the-ear assembly

- 1 Choose the size of earloop that fits most comfortably. Align the earloop as shown and insert it onto the headset. Rotate the earloop up 90°.

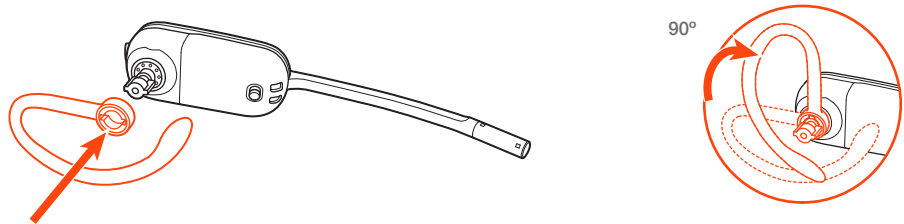

Note: Ensure the earloop is flat against the headset before rotating.

- 2 Choose the size and style of eartip that fits most comfortably. Align the eartip with the notch facing the microphone as shown. Press on to attach.

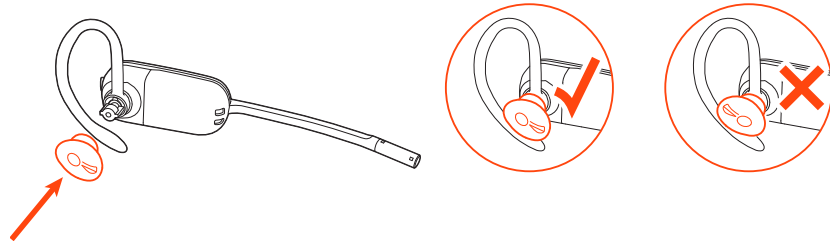

Note: Ensure the large end of the eartip points to the microphone.

- 3 To correctly position your headset, see [Position Your Headset](#).

Position your headset

When you wear the headset, the microphone should rest as close to your cheek as possible without touching. The microphone can be adjusted inward by the pivoting earpiece to optimize the position of the headset.

- 1 Slide the headset over and behind your ear and fit the eartip into your ear.
- 2 Holding the base of the headset, push it in and back towards your ear to allow the pivoting earpiece to bring the microphone close to your mouth. As the base of the headset moves backwards, you will feel soft clicks until the microphone rests close to your cheek.

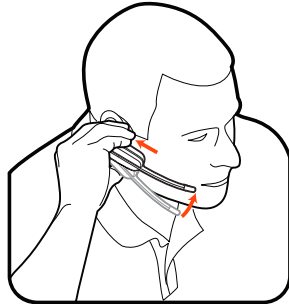
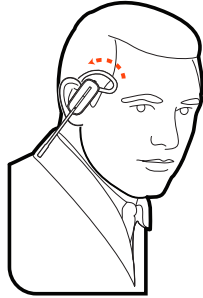

Over-the-head assembly

- 1 Hold the headband so it is aligned to receive the headset as shown and insert the headset into the headband.

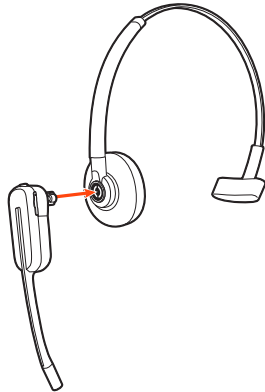

- 2 Rotate the headset up. The headband can be worn on the right or left side.

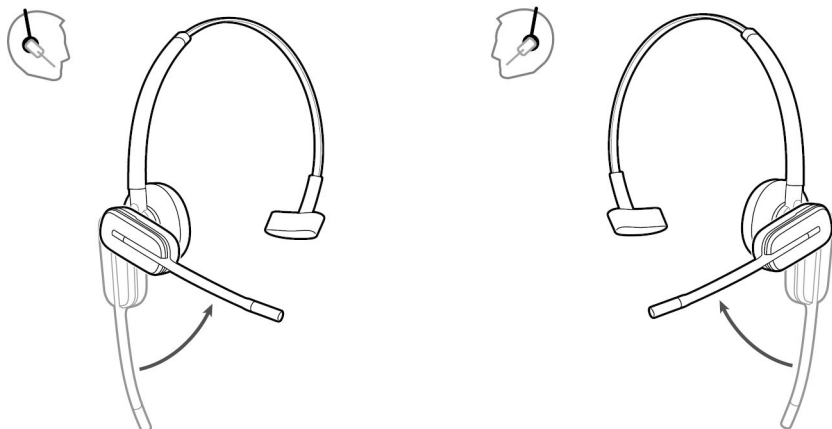

- 3 To optimize the position of the headset, push the headset in so the microphone is close to your mouth.

Behind-the-head assembly

- 1 Align the headband as shown. Ensure the headband sits flat against the headset, then rotate it up 90°. If you want to wear it on the left, switch the stem to the left side of the headband.

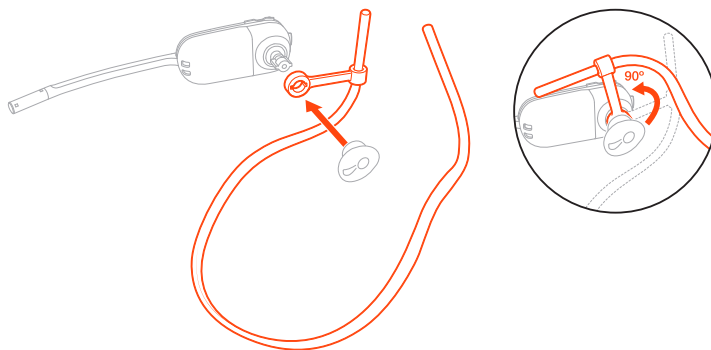

- 2 Choose the size and style of the eartip that fits most comfortably. Align the eartip with the notch facing the microphone as shown. Press on to attach.

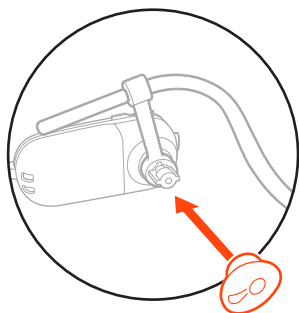

Note: Ensure the large end of the eartip points to the microphone.

- 3 To position your headset correctly, first slide the stem of the headband so the headset fits comfortably.

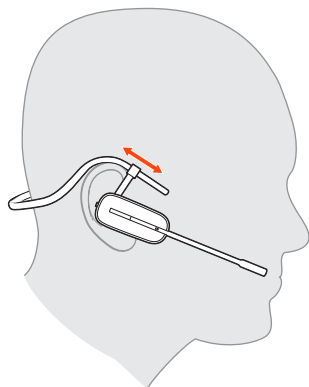

- 4 With a finger on the headset indicator light, push in until the microphone rests as close to your cheek as possible without touching.

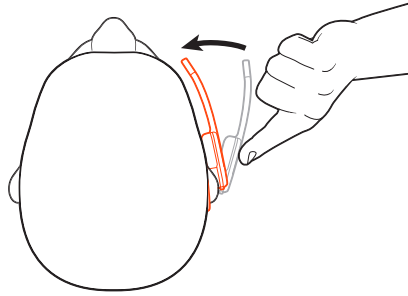

Charge

Charge your headset and spare battery

Charge your headset

Place the headset in the charge cradle. The headset charging LED flashes when charging the headset and turns off when the headset is fully charged. Charge for at least 20 minutes prior to the first use. A full charge takes up to 3 hours.

Charge spare battery

Charge spare battery, if applicable, by placing in the battery compartment of your charge stand or charge accessory and connecting to USB power source.

Replace battery during a call

You can replace your headset battery even during active calls.

- 1 While on a call, remove your headset battery. Your headset mutes.
- 2 Replace with a charged spare battery.
- 3 You hear "base connected" and "mute off" when the battery is replaced and you are reconnected to your call.

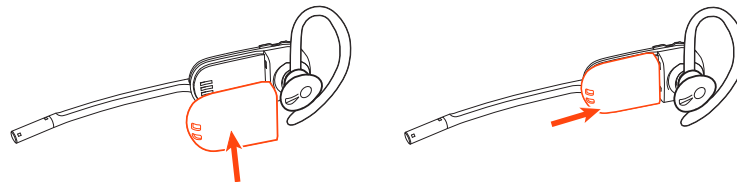







Talk time

With a full charge, the headset provides up to 5 hours of continual talk time. Changing batteries provides unlimited talk time.

Headset battery status

Determine your headset battery status:

- Listen to the voice prompts after powering on the headset
- With your headset idle, view the headset battery  level on your base display's homescreen
- View in Poly Lens Desktop App

Headset battery status	Base display homescreen or Poly Lens Desktop App
Battery full	
Battery high	
Battery medium	
Battery low	
Battery critical	

Tip: To reset the accuracy of the talk time alert, deplete the headset battery then charge fully.

Replace rechargeable battery

Replace your rechargeable battery after 3 years or 500 charge cycles, whichever occurs first.

To ensure replacement batteries meet high quality standards and for optimal performance, use only Poly batteries.

Load software

Download Poly Lens App to get the most out of your device. Some softphones require the installation of Poly software to enable device call control (answer/end and mute) functionality. Download: poly.com/lens.

- Enable features
- Change settings
- Configure call control for softphones
- Update device firmware
- Manage notifications and alerts
- Schedule health and wellness reminders

Update your Poly device

Keep your firmware and software up-to-date to improve performance and add new features to your Poly device.

Update your device using Poly Lens App. Download at poly.com/lens.

Pair to your mobile phone

To take mobile calls or stream mobile audio through your headset, pair your mobile phone and base.

- 1 Press the base navigation wheel on the left side of your base to go to your settings menu and add a mobile phone. Scroll and press to select: **Devices > Add Device > Mobile**.

Note: To exit a menu, press the Back button on the left side of your base.

- 2 Go to Bluetooth settings on your mobile phone and select Poly Savi x400. Once successfully paired, you see "Connected" on the base's mobile menu and your base home screen displays the mobile phone icon.

Auto connect feature

Once you have paired and connected your mobile phone to the base, the headset system automatically connects to it when your paired mobile phone is in range of your base.

Manage this feature in Poly Lens Desktop App by going to **Settings > Wireless > Auto-connect to Mobile Phone**.

Transfer mobile audio

When you answer a call, the audio stays with that device (if you answer with the headset, the audio stays on the headset; answer with your mobile phone, the audio stays on your mobile).

- 1 To transfer a mobile call **from your headset to your mobile phone**, press the base mobile phone button for 3 seconds. The green LED turns off.
- 2 To transfer a mobile call **from your mobile phone to your headset**, press the base mobile phone once. The green LED turns on.

Disconnect your mobile phone

To disconnect your mobile phone from the headset system, do one of the following:

- From your mobile phone, disconnect from your headset system by selecting **Bluetooth settings > Poly Savi x400 > Disconnect**.

Note: Menus vary by mobile phone.

- Disable Bluetooth using your base. Scroll and press the navigation wheel to select: **Advanced > Base > Bluetooth > Off**.

Note: To exit a menu, press the Back button on the left side of your base.

- Disable Bluetooth using Poly Lens Desktop App on your computer. From Poly Lens Desktop App, disable Bluetooth by selecting **Settings > Wireless > Bluetooth > Off**.

The basics

Headset Basics

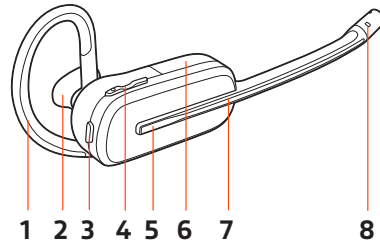

- 1 Earloop
- 2 Eartip
- 3 Mute button
- 4 Volume button
- 5 Call button/Press to interact with Microsoft Teams (app required)
- 6 Battery
- 7 Headset LED
- 8 Microphone

Be safe

Please read the safety guide for important safety and regulatory information before using your new device.

Power on your headset

To turn on the headset, slide the Power button to reveal green.

Note: Headset design may vary.

Adjust volume

- **Headset volume** Fine-tune your headset volume by adjusting the headset's volume up (+) and down (-) controls.
- **Desk phone volume** Adjust your base's volume settings when your voice or your caller's voice is too quiet/loud during a desk phone call. Press and scroll the base navigation wheel: **Advanced > Desk phone > Speaker or Mic > Adjust level**. If your voice is too quiet/loud, adjust the Mic 🗣️ volume. If your caller's voice is too loud/quiet, adjust the Speaking 🗣️ volume.

Note: To exit a menu, press the Back button on the left side of your base.

Adjust headset microphone volume (desk phone/softphone)

Place a test softphone call and adjust desk phone, softphone volume and PC sound volume accordingly.

Launch Microsoft Teams (Teams model only)

You can easily open and use your Teams desktop application with your Microsoft Teams-certified headset system.

Your base and headset each have a Teams  button to quickly open and use the Microsoft Teams desktop app. The base Teams button illuminates when you have a meeting or notification.

Tip: Your headset's Call  button is also a Teams button.

- When not on a call, tap the Teams  button to view Microsoft Teams app on your computer.
- When the base's Teams button LED pulses purple, tap to join your meeting.
- When the base's Teams button LED is solid purple, tap to view your Teams notifications.

Note: Teams model and Teams desktop application required. Teams mobile application is not supported.

Change your default line

Change the default outbound phone line/audio channel.

With the system idle, do one of the following:



- On your base, press the desired audio button for 4 seconds until it flashes 4 times.
- Download and open Poly Lens Desktop App on your computer, go to **Device Name > Settings > General > Default Phone Line** and choose the desired audio line.

Get a dial tone



To open an audio channel or get a dial tone, press the headset Call button for 1 second while the system is idle; the default base Audio button turns green.

Stream audio

Listen to streaming media on your headset.

To stream audio from your computer or mobile phone, first press the **computer**  or **mobile**  base Audio button and then play the audio.

Make, answer, end calls

On the base there are 3 Audio source buttons: desk phone , computer , and mobile . These buttons allow you to switch to a different audio source.

Make a call

Make a call using your headset system.

- 1 Tap an Audio button on the base.

: **Desk phone only:** Press the desk phone's Headset  button or manually remove the handset if you don't have an HL10 lifter or EHS cable.

- 2 Dial from your softphone/mobile phone/desk phone.

End/take a call

To answer/end a call, tap the corresponding Audio button or tap the headset call button.

: **Desk phone only:** If you don't have an HL10 lifter or EHS cable, press the desk phone's Headset  button or remove the handset when answering a call and hang up when ending a call.

Tip: Headset call control for the computer requires Poly software and softphone compatibility. See "Download software."

Mute

- 1 To mute your headset during on a call, do one of the following:

- Press the headset Mute button. You hear "Mute on."
- Standard model only: press the base Mute button. When muted, you hear "Mute on" and your base Audio button and Mute button LEDs turn red.

Note: Teams model base does not include a Mute button.

- 2 To unmute your headset, do one of the following:

- Press your headset Mute button. You hear "Mute off" and your base Audio button LED turns green.
- Press your base's active Audio button. You hear "Mute off" and your base Audio button turns green.
- Standard model only: to unmute, press the base Mute button. You hear "Mute off" and your base Mute button LED turns off.

Answer a second call

- 1 While on a call, press the headset Call button for 2 seconds to answer the second call. This will place the first call on hold.
- 2 To switch between the calls, press the headset Call button for 2 seconds.

Reject a Mobile Call

To reject an incoming call, hold the base mobile button down for 3 seconds.

Merge a call from 2 sources

Merge call audio from 2 sources to create a mini conference call.

Simultaneously hold the base buttons of any two of the three audio sources (desk phone 📞, computer 🖥️, or mobile phone 📱) until the LEDs become solid green to combine the audio into a merged call.

Set up a conference call

You can set up a conference call with 3 additional headsets.

Join Savi headsets automatically

- 1 While on a call, place the guest headset into the primary user's charge cradle.
- 2 The primary user will hear a request "Conference requested." To accept the request, press the primary user's headset Call button. View conference call status on your base's screen or in Poly Lens Desktop App.

Join Savi headsets manually

- 3 While on a call, press and scroll the base navigation wheel to select **Conference > Add Headset**.
- 4 On guest headset, press and hold the Volume up button or turn the Volume wheel up until the headset LED lights up. Method varies by model.
- 5 The primary user will hear "Conference requested." To accept the request, press the primary user's headset Call button. View conference call status on your base's screen or in Poly Lens Desktop App.

Exit a conference call

- 6 Guest headsets can remain as guests through multiple calls. To remove a guest headset, either press the guest headset's Call button or dock the primary user's headset in the charge cradle.

More Features

Change voice prompt language

Change the voice prompt language on your headset in Poly Lens Desktop App.

Optimize audio quality

There are 3 audio modes: wideband stereo (hybrid), wideband (conversation) and multimedia (music).

To optimize your audio quality for your activity, with the system idle, do one of the following:

- Press the headset Mute button for 4 seconds. The headset cycles through the modes with each 4 second press.
- Configure in Poly Lens Desktop App: Select **Product name** > **Settings** > **Wireless** > **Audio quality** and select from 3 audio modes.

Limit office noise

You can limit the amount of nearby conversation that is transmitted during your calls. There are 3 modes: No Limiting, Best Audio, and Open Office.

Customize feature in Poly Lens Desktop App by going to **Product name** > **Settings** > **General** > **Close conversation limiting**. Select from 3 modes.

Note: For best performance, bend the microphone boom so it is approximately two finger widths from the corner of your mouth.

Remove or connect a headset charge cradle

Remove a headset charge cradle from the base or connect a new charge cradle.

- 1 Locate the cradle release slider below the cradle on the back of your base and slide and hold it to the left to unlock the cradle.
- 2 Pull the cradle up to remove it from the base.
- 3 To connect the headset charge cradle to the base, align the cradle pins with the base and press firmly. You hear it click into place.

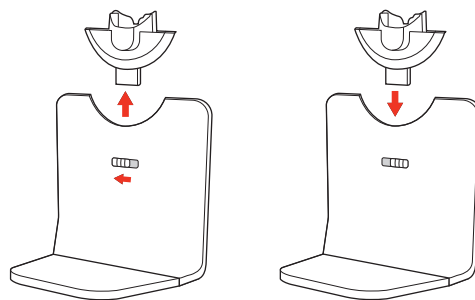

Set the range

Changing the range can help with PC audio quality, improve user density or restrict range of users.

You can adjust the range setting in Poly Lens Desktop App.

Setting	Range
High (Default)	up to 300 ft.
Medium	up to 150 ft.
Low	up to 50 ft.

Automatic secure subscription

With your system idle, placing a new headset in the headset charge cradle automatically subscribes it to the base, making it the primary headset.

Troubleshooting

Headset

I can't hear a dial tone in the headset.

- Make sure your headset is charged.
- Make sure your headset is subscribed to base by placing it in the charge cradle.
- Adjust the configuration switch (F-A) on the back of the base until a dial tone is heard. The default **A** works for most phones.
Attention: Use configuration **D** for Cisco phones. Cisco phones connected with EHS cable use configuration **A**.
- Make sure your desk phone is connected correctly to your base. See [Desk phone setup details](#) on page 7.
- If your base is connected to your desk phone's dedicated headset port, press the desk phone's headset button to hear a dial tone.
- If your base is connected to your desk phone's dedicated headset port, press the desk phone's headset button and base's desk phone button to hear a dial tone.
- If your base is connected to your handset port, manually remove the handset to hear a dial tone (if you do not have an EHS cable or HL10 lifter).
- Make sure your HL10 lifter is lifting the handset high enough to operate the hookswitch; set to a higher setting if necessary.
- Adjust the headset's listening volume. See [Adjust volume](#) on page 19.
- If the volume is still too low, adjust the desk phone listening volume on the base. See [Adjust volume](#) on page 19.

I hear static.

- Make sure there is at least 12 inches between your base and your computer, and 6 inches between your base and your telephone. If adjusting the distance doesn't help, your headset is going out of range, move closer to the base. See [Position Your Base](#)

The sound is distorted.

- Lower the desk phone speaking volume and/or desk phone listening volume on the base. For most telephones the correct setting is position 2. See [Adjust volume](#).
 - If your desk phone has a volume control, lower until the distortion disappears.
 - If the distortion is still present, adjust the headset volume control to lower the headset speaker volume. See [Adjust volume](#) on page 19.
 - Make sure there is 12 inches between your base and your computer, and 6 inches between your base and your telephone. See [Position Your Base](#).
-

I hear echo in the headset.

- Lower the desk phone speaking volume and/or desk phone listening volume on the base. For most telephones the correct setting is position 2. See [Adjust volume](#) on page 19.
- If the audio level is too low in this position, increase the headset volume. See [Adjust volume](#) on page 19.
- If your speaking volume is too low for your listener in this position, adjust the position of the headset to make sure the microphone is as close as possible to your mouth.

People I talk to can hear a buzz in the background.

- Move the base further away from your phone. See [Position Your Base](#).
- If the base power supply is plugged into a power strip, plug it into the wall directly.

Desk Phone

The handset lifter is installed but does not lift the handset.

Be sure the handset lifter power cord is firmly pushed into the handset lifter jack on the base.

When I use an EHS cable with a Poly VVX phone and I answer a call with my headset, the call fails.

This is a known issue. Press one of the base audio buttons (computer/mobile/desk phone) to answer the incoming call.

Mobile

Pairing problems

- Ensure your mobile phone is paired to the base. See [Pair to your mobile phone](#) on page 18.
- Ensure Bluetooth is activated on your mobile phone.
- Once successfully paired, you see "Connected" on the base's mobile menu and your base home screen displays the mobile phone icon.

Why doesn't the base automatically reconnect with my mobile phone?

- Ensure Poly Lens Desktop App has been installed.
- Enable feature in Poly Lens Desktop App: **Settings > Wireless > Auto-connect to mobile phone.**

Softphone

When I dial from my softphone application, nothing happens.

- Ensure your headset is powered on.
- Press the headset Call button.
- Make sure your headset is charged.
- Fine tune the headset volume.
- Press the Computer audio button on your base.
- Ensure your base is connected to your computer with the included USB cable.
- Ensure that your headset is the default sound device by going to your Sound Control Panel (Windows) or your Sound System Preferences (Mac).
- Ensure that Poly Lens App software is installed. To download, visit poly.com/software.
- Ensure that you are using a compatible softphone application. For a list of compatible softphones, visit poly.com/SoftphoneCompatibility.
- If Poly Lens App is not installed and you do not have a compatible softphone, you must first press the headset Call button and then use the softphone interface to place/answer/end calls.
- Restart your computer.

How do I interact with Microsoft Teams on my Teams-certified headset system?

- Tap your headset's Call button to interact.
- Tap your base's Teams button to interact with Microsoft Teams or to view notifications.

Note: Teams model and app required.

Does my Microsoft Teams-certified headset system work with other softphones?

Yes, while your headset is optimized for Microsoft Teams, it can be configured to use with other supported softphones. Set your target phone by going to Poly Lens Desktop App > **Softphones > Software Settings > Target Softphone**

When you configure another softphone, the Call button:

- doesn't interact with Teams
- doesn't go to Teams notifications
- will not launch Cortana

Speaking and/or listening volume is too low or too high.

- Adjust headset listening volume.
- Adjust listening/speaking volumes in the computer's sound control panel/system preferences.
- Adjust listening/speaking volumes in the softphone application.

The sound is distorted or I hear an echo in the headset.

- Reduce speaking and/or listening volume on the computer using your softphone application.
- Point microphone towards your mouth.
- If the distortion is still present, lower the volume on the headset.

I can no longer hear any audio through my PC Speakers.

- Change the default sound device by going to your Sound Control Panel (Windows) or your Sound System Preferences (Mac) and selecting your PC speakers or internal speakers.

There is no audio connection between my headset and computer.

- Press the Computer audio button on your base.
 - Ensure that your headset is the default sound device by going to your Sound Control Panel (Windows) or your Sound System Preferences (Mac).
 - Fine tune the headset volume.
 - Unplug the USB cable and then reconnect it.
 - Quit and then re-start your PC or softphone application.
-

Safety warnings

Safety Instructions

To reduce the risk of fire, electric shock, injury to persons and damage to property, read all operating instructions and the following safety instructions before using your Poly product. Operating, storage and charging temperature is 10°C to 40°C (50°F to 104°F).

- Only use those Poly products and accessories designed for use with this product.
- If you experience a skin irritation after using this product, discontinue use and contact Poly.
- CHILDREN. Never allow children to play with the product-small parts may be a choking hazard.
- Do not disassemble the product as this may expose you to dangerous voltages or other risks. Incorrect reassembly can cause electric shock or fire when the product is subsequently used.
- Unplug, discontinue use and contact Poly if the product overheats or has a damaged outer casing, cord or plug.
- Exposure to high volume sound levels or excessive sound pressure may cause temporary or permanent damage to your hearing. Although there is no single volume setting that is appropriate for everyone, you should always use your headset/headphones with the volume set at moderate levels and avoid prolonged exposure to high volume sound levels. The louder the volume, the less time is required before your hearing could be affected. You may experience different sound levels when using your headset/headphones with different devices. The device you use and its settings affect the level of sound you hear. If you experience hearing discomfort, you should stop listening to the device through your headset/headphones and have your hearing checked by your doctor. To protect your hearing, some hearing experts suggest that you:
 - 1 Set the volume control in a low position before putting your headset/headphones on your ears and use as low a volume as possible.
 - 2 Avoid turning up the volume to block out noisy surroundings. Whenever possible, use your headset/headphones in a quiet environment with low background noise.
 - 3 Limit the amount of time you use headsets/headphones at high volume levels.
 - 4 Turn the volume down if the sound from the headset/headphones prevent you from hearing people speaking near you.

See poly.com/healthandsafety for more information on headsets/headphones and hearing.

- If you use your headset/headphones while driving, check local laws regarding use of a mobile phone and headset, and ensure your attention and focus remain on driving safely. Use of a headset/headphones that covers both ears will impair your ability to hear other sounds and in most regions is illegal to use while operating a motor vehicle or riding a bicycle and may be a serious hazard for you and others.
- If this product includes earbuds/eartips, install and use them in accordance with the instructions provided. Do not force earbuds/eartips down the ear canal. Consult a doctor if they become lodged in the ear canal.
- Plug the mains adapter or charger into a socket-outlet that is near to the equipment and will be easily accessible.

Battery Warnings for Wireless Products

- If your product has an embedded, non-replaceable battery, do not attempt to open the product or remove the battery as this may cause injury and/or damage the

product. If your product has a replaceable battery, use only the battery type supplied by Poly. Remove a spent battery promptly.

- Replace rechargeable batteries after three years or 300 charge cycles, whichever occurs first.
- Do not dispose of the product or battery in a fire or heat above 40°C (104°F).
- Do not expose the battery to extremely high temperatures. It may result in an explosion or the leakage of flammable liquid or gas.
- Do not open, deform or mutilate the battery. There may be corrosive materials which can cause damage to eyes or skin and may be toxic if swallowed.
- Never put batteries in mouth. If swallowed, contact a physician or poison control center.
- Swallowing may lead to burns, perforation of soft tissue, and death. Severe burns can occur within 2 hours of ingestion.
- Always store batteries where children cannot reach them.
- Do not allow any battery or its holder to contact metal objects such as keys or coins.
- RECYCLING: The product battery must be recycled or disposed of properly. Contact your local recycling center for battery removal and proper disposal.
- Use only the charger supplied by Poly to charge the product and follow the charging instructions provided. Alternatively, if your headset is designed to be charged with your cell phone charger, use only cell phone chargers approved and provided by your cell phone manufacturer. Do not use the charger for any other purpose. Ensure that the voltage rating corresponds to the power supply you intend to use.

Support

NEED MORE HELP?

poly.com/support

HP Inc.

1501 Page Mill Road
Palo Alto 94304, U.S.A.
650-857-1501

HP Deutschland GmbH

HP HQ-TRE
71025 Boeblingen, Germany

HP Inc UK Ltd

Regulatory Enquiries, Earley West
300 Thames Valley Park Drive
Reading, RG6 1PT
United Kingdom

© 2023 Poly. DECT is a trademark of ETSI. All trademarks are the property of their respective owners. HP Inc.

Model ID: CB8421 (may be followed by /A, /J or /P), S8240T (may be followed by /A or /P). System sentence: Savi 8445 Office has a CB8421 base (may be followed by /A, /J or /P) and a S8240T headset (may be followed by /A or /P).

222052-06 04.23